

2017



Mould Cutting Tools
模具刀具

Parts Cutting Tools
零件刀具

**Automobile Processing
Cutting Tools**
汽车配件加工刀具

Medical Cutting Tools
医疗刀具

Aerospace Cutting Tools
航空用刀具

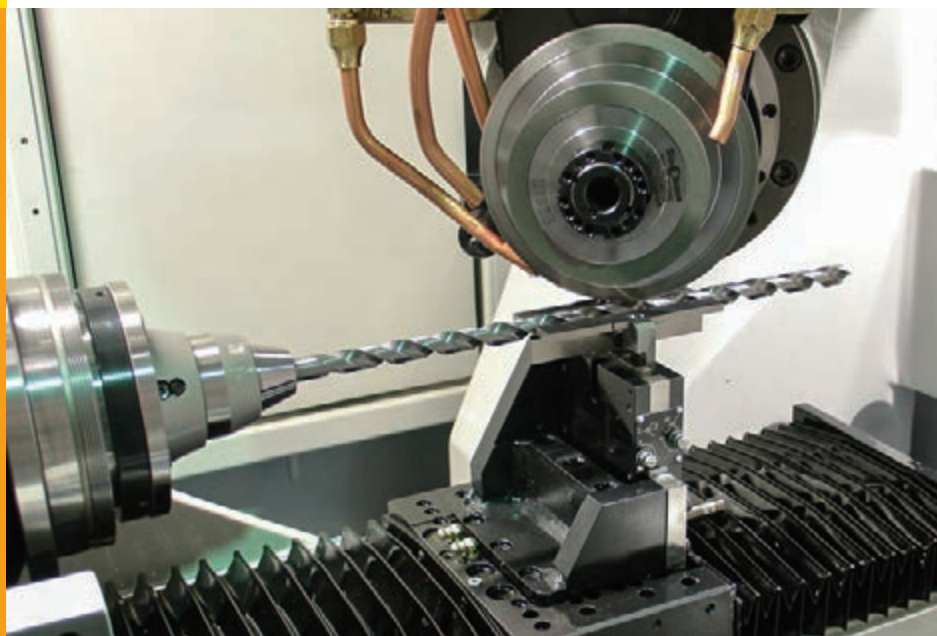

欧思克切削技术有限公司
OSK Cutting Technology Co., Ltd.

www.osktool.com



欧思克精密工具有限公司成立于 2006 年，专精于碳化钨钻头、铰刀、铣刀等切削刀具的生产与销售。产品主要应用于航空航天、汽车、机械、电子、模具加工等领域，特别针对高速高硬度和难切削材料的加工更具优势。

现在，公司拥有瑞士 ROLLOMATIC、德国 WALTER 和澳大利亚 ANCA 多台 CNC 刀具磨床，以及德国的 ZOLLER 和日本 Mitutoyo 的检测设备，为产品的稳定性提供了保证。机种众多，应变灵活，尤其是产品零件加工的成型刀具生产更加方便。

近期，新厂房全面投入使用，更加发挥了公司软硬件的配套作用。DMG 加工中心的引进以及刀具测试和切削技术应用中心的成立，可不断地对公司生产的刀具进行切削实验并改良提升，同时为客户提供准确的数据和最佳的切削效果。

未来，公司将侧重于新产品的开发和研究，不断地引进高精设备，吸纳高级技术人才，逐步完善独立的研发中心，加强与世界级大品牌的技术合作。提升品质，将“OSK”打造为世界一流的刀具品牌供应商，为加快金属加工行业的高速化和国产化进程做出卓越的贡献。

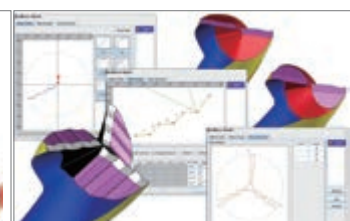
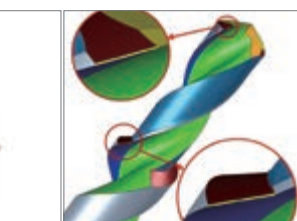
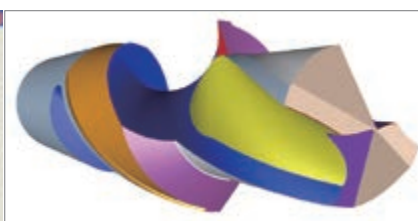
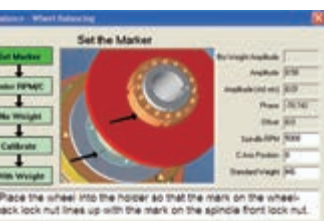



OSK Precision Tools Co., Ltd., established in 2006, is specialized in the manufacturing and sales of tungsten carbide drills, reamers, end mills and other cutting tools. Products are mainly used in aerospace and aviation, automobile, machinery, electronics, mould processing, and other industries, especially advantageous in the high-speed processing of high-hardness and difficult-to-cut material.

Now, the Company has several CNC cutter grinding machines from Swiss **ROLLOMATIC**, German **WALTER** and Australian **ANCA**, as well as several testing equipment from German **ZOLLER** and Japanese **Mitutoyo**. All these machines and equipment are the guarantee for a stable product quality. Different types of machines are flexible for production, especially convenient for special profile cutters for product parts.

Recently, the new factory plant was completed and put into use, which improves the integrated use of the Company's software and hardware. The introduction of DMG machining-center and the establishment of cutter testing and cutting technology application center will continuously conduct cutting tests and improve the quality of cutters manufactured by the Company, as well as will provide customers with accurate data and premium cutting results.

In the future, the Company will focus on the research and development of new products, continuously introduce high-precision equipment, recruit senior technicians, gradually consummate an independent R & D center, and step up technical cooperation with world-class manufacturers. We are going to improve quality, develop "OSK" to be a world-class cutter supplier, and make contribution to the acceleration and localization process of metal processing industry in China.

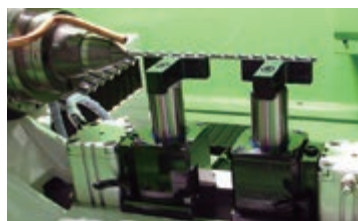

刀具类型: 球头铣刀, 立铣刀, 圆鼻铣刀, 深沟铣刀

适用材料: 一般钢, 工具钢, 合金钢, 热处理钢

- 多用途, 高精度, 高转速, 高进给

KPM Series

Tool type: Ball End Mills, End Mills, Corner Radius, Rib End Mills

Applicable materials: General Steel, Tool Steel, Alloy Steel, Heat Treated Steel

- Multi Purpose, High Precision, High Speed, High Feed

适用领域:

低硬度 (HRC45) 模具, 中硬度 (HRC55) 模具, 零件

Application Areas: Low hardness mold (HRC45), medium hardness mold (HRC55), Parts

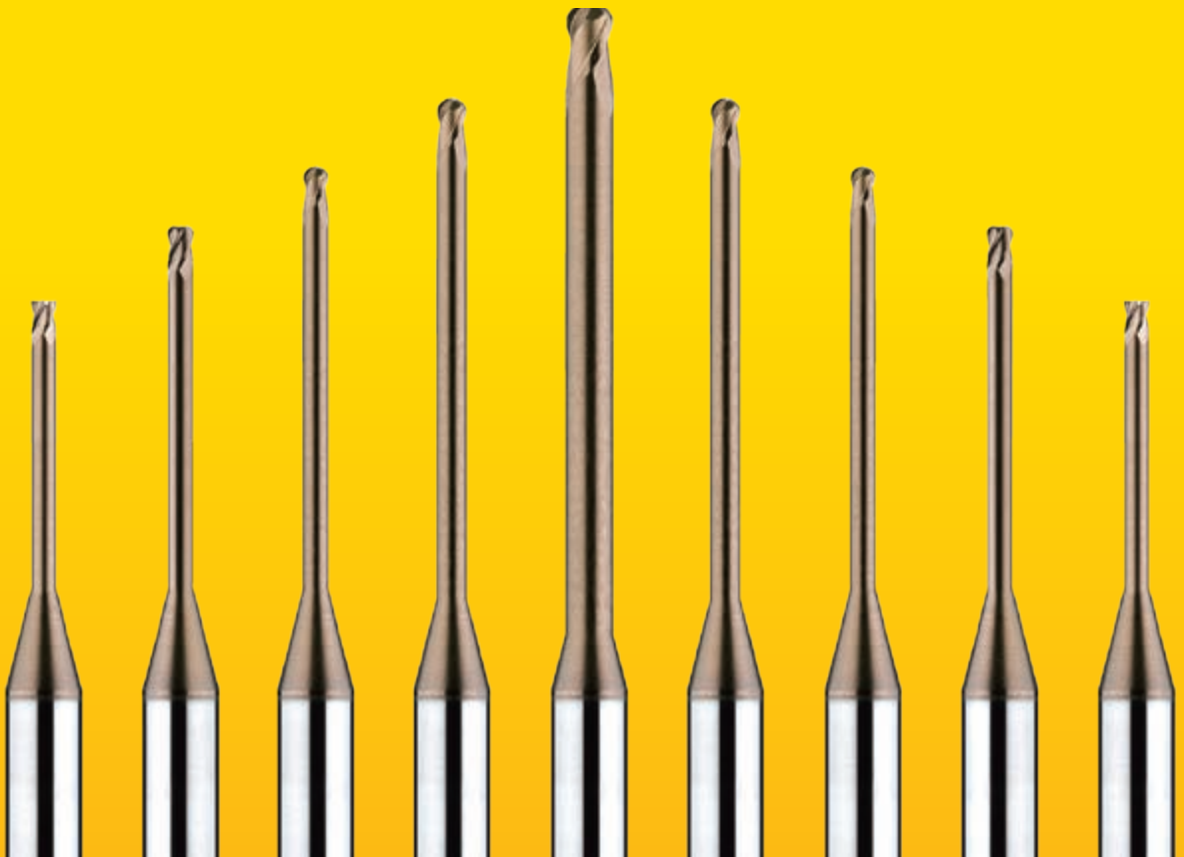

KPM



KHM

刀具类型: 球头铣刀, 立铣刀, 圆鼻铣刀, 深沟铣刀

HRC68 以下高硬度, 难切削材料的加工

- 高硬度, 高精密, 高转速, 高进给

KHM Series

Tool type: Ball End Mills, End Mills, Corner Radius, Rib End Mills

HRC68 the following high hardness, difficult cutting material processing

- High Precision, High Speed, High Feed, High hardness

应用领域: 高硬度模具 (HRC65), 零件

Application Areas: High hardness mold (HRC65), Parts

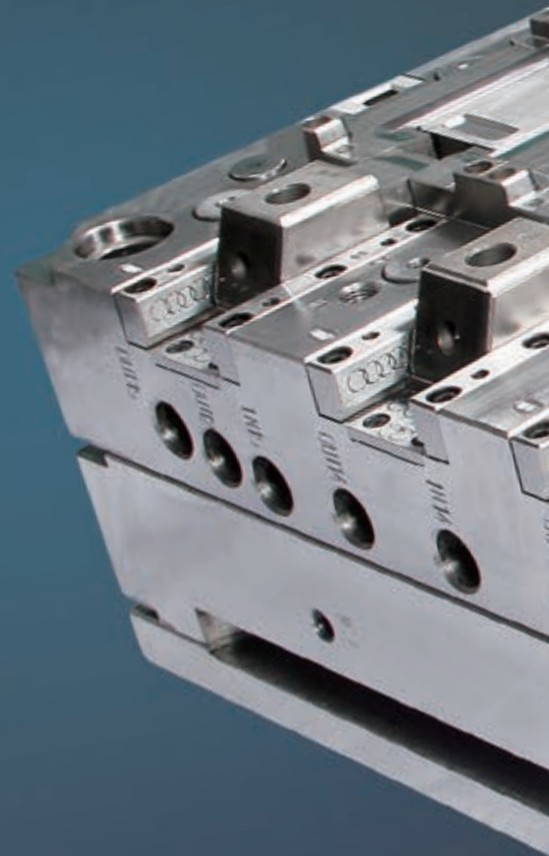
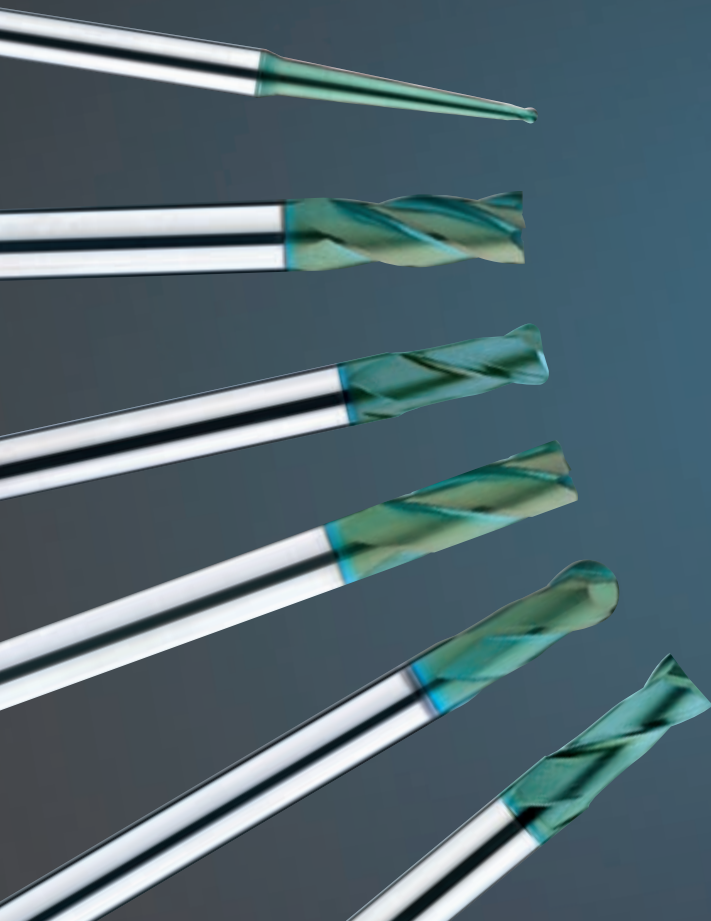

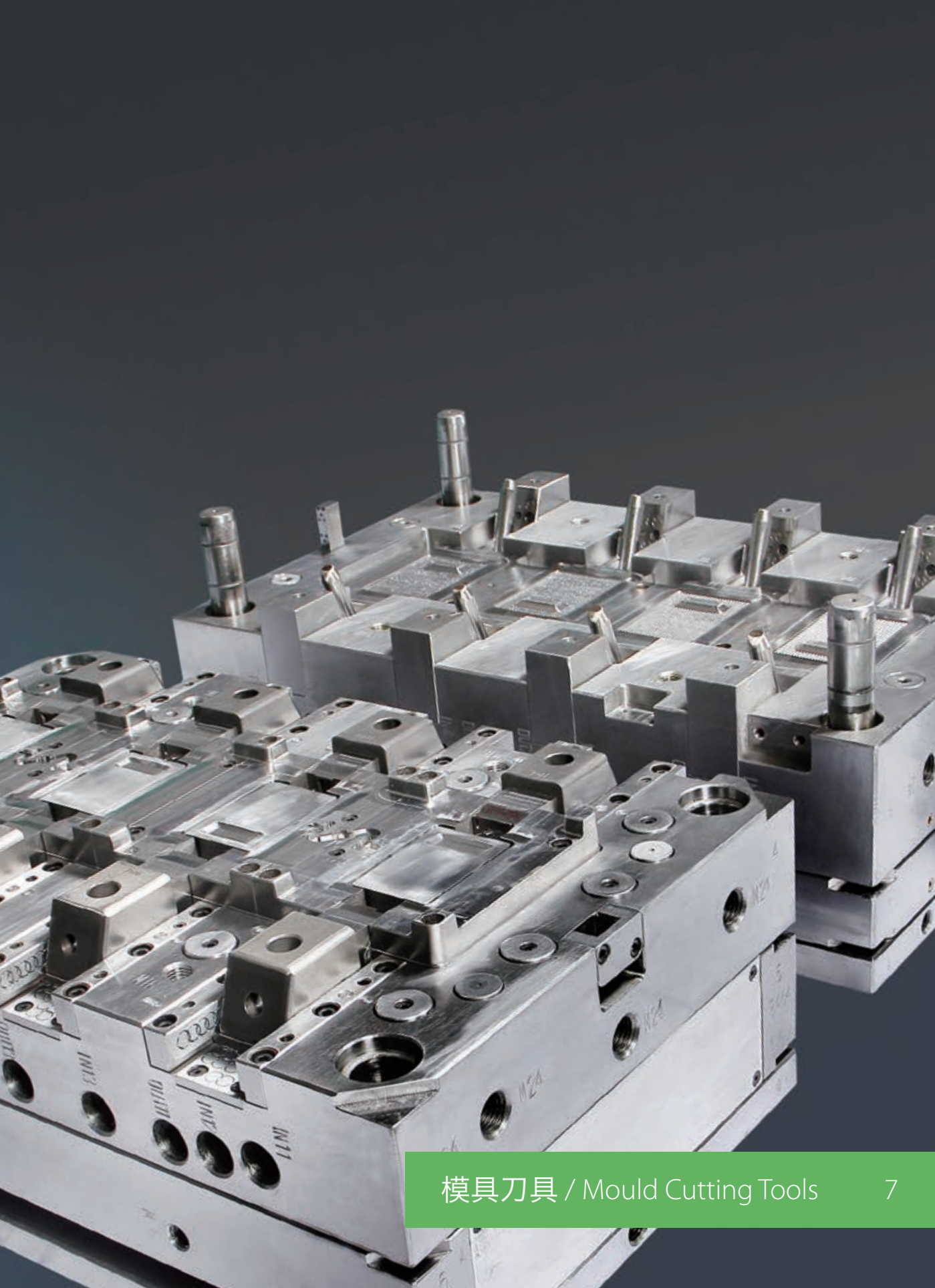



KDM

刀具类型: 球头铣刀, 立铣刀, 圆鼻铣刀, 深沟铣刀

适用材料: 石墨, 碳纤, 中 / 高碳钢

- 高精度, 高转速, 高耐磨

KDM Series

Tool type: Ball End Mills, End Mills, Corner Radius, Rib End Mills

Applicable materials: Graphite, Carbon Fiber, Medium / High Carbon Steel

- High Precision, High Speed, High Wear Resistance

应用领域: 石墨, 碳纤

Application: Graphite, Carbon fiber

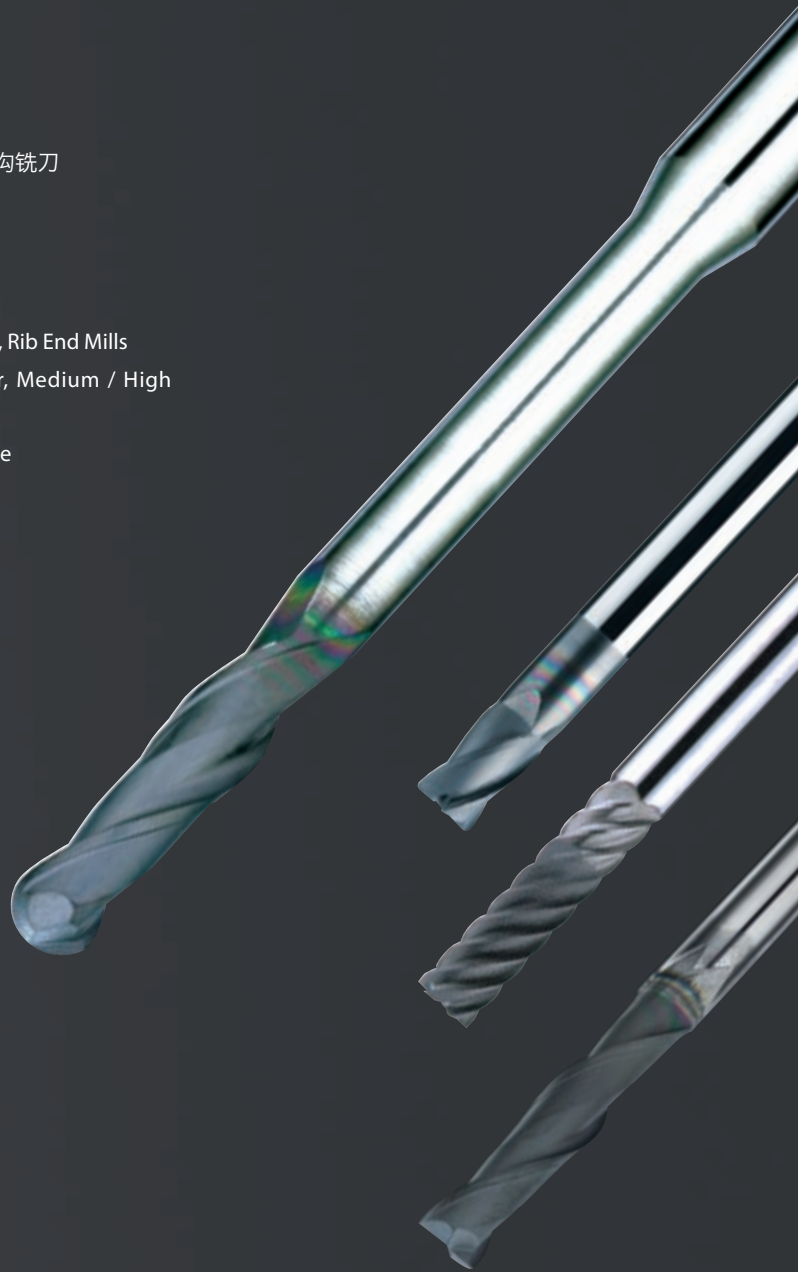



KAM



刀具类型: 球头铣刀, 立铣刀, 高光铣刀, 非标铣刀

适用材料: 铝, 铝合金

- 高光度, 高效率, 高耐磨

KAM series

Tool Type: Ball End Mills, End Mills, Non-Standard End Mills

Applicable Materials: Aluminum, Aluminum Alloy

- High Luminosity, High Efficiency, High Wear Resistance

应用领域: 信息技术产业 (手机, 电脑……), 零件

Application Areas: Information technology industry
(mobile phones, computers...), Parts





KSM

刀具类型: 球头铣刀, 立铣刀, 高光铣刀, 非标铣刀

适用材料: 不锈钢, 合金钢

- 高光度, 高效率, 高耐磨

KSM series

Tool Type: Ball End Mills, End Mills, Non-Standard End Mills

Applicable Materials: Stainless Steel, Alloy Steel

- High Luminosity, High Efficiency, High Wear Resistance

应用领域: 信息技术产业 (手机, 电脑……) 零件加工, 其它零件加工

Application Areas: Information technology industry (mobile phones, computers...) Parts

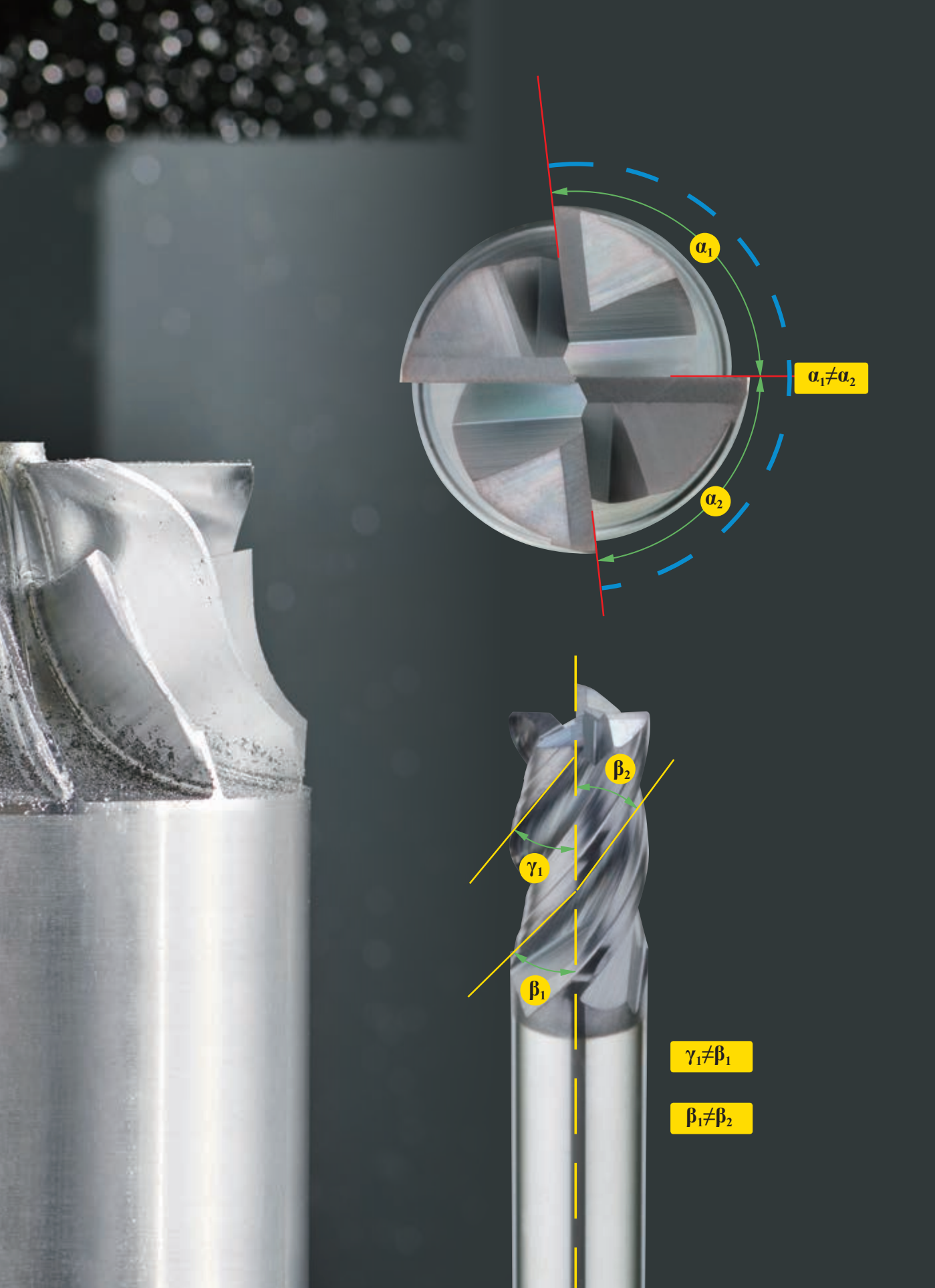

钻头系列， 铰刀系列， 螺纹刀具

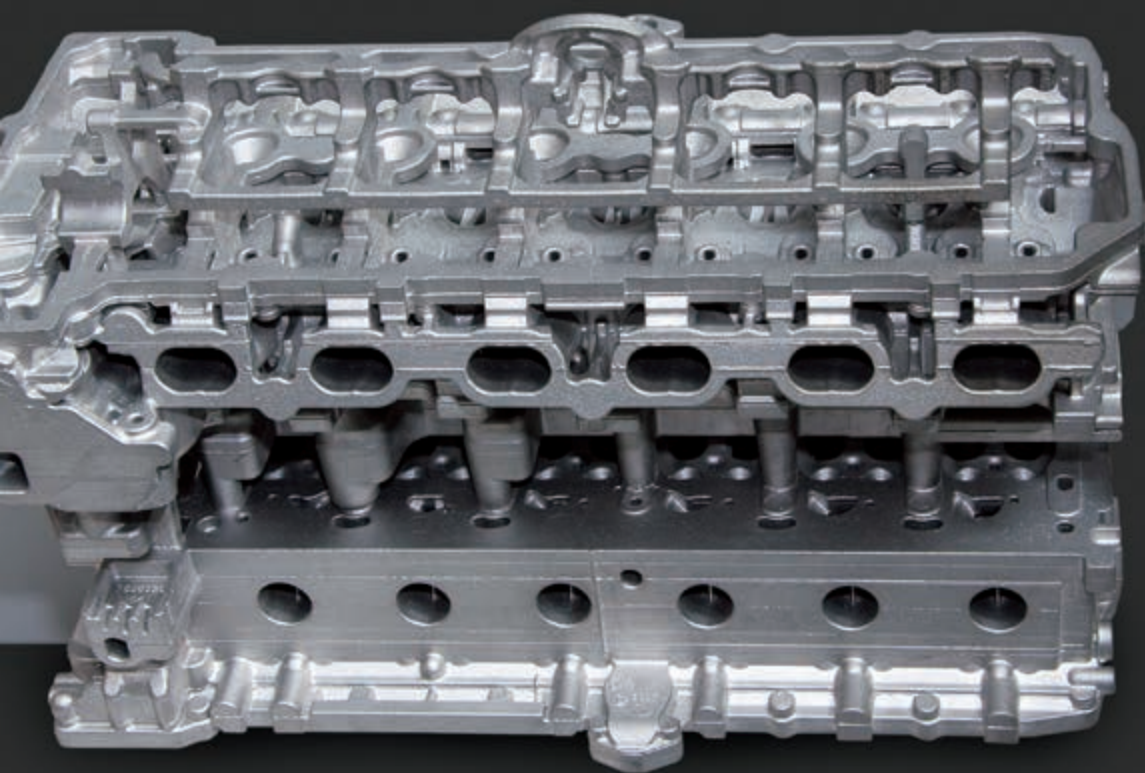

刀具类型: 内冷钻头, 外冷钻头, 直槽铰刀, 螺旋槽铰刀, 螺纹铣刀
适用材料: 钢件, 铸铁, 合金钢

Drill , Reamer , Thread Mill

Tool Type: With Coolant Drill, Without Coolant Drill, Straight Reamer, Spiral Reamer, Thread Mills

Applicable Materials: Steel, Cast Iron, Alloy Steel

应用领域: 汽车零部件, 压缩机零部件, 泵业

Application Areas: Automotive parts, Compressor parts, Pump

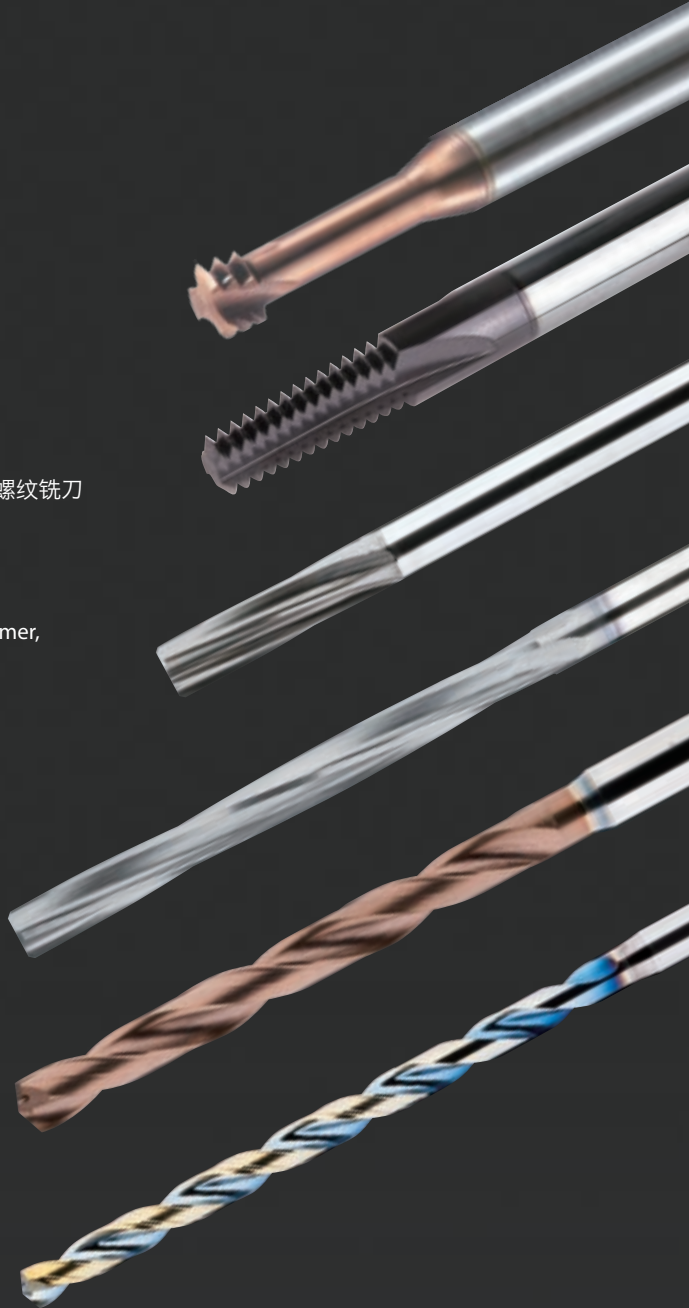

KNM / KTM



刀具类型: 球头铣刀, 立铣刀

适用材料: 耐热合金, 镍合金, 钴合金, 钛, 钛合金

KNM Series

Tool Type: Ball End Mills, End Mills

Applicable Materials: Heat Resistant Alloy, Nickel alloy, Cobalt alloy, Titanium, Titanium Alloy

应用领域: 医疗器械, 航空

Application areas: medical devices, Aerospace

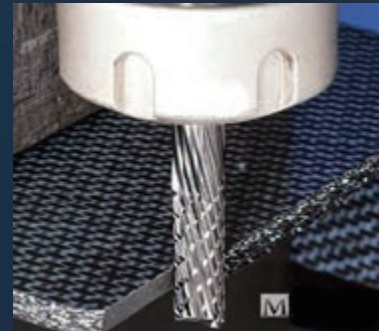









24h service

让天下没有难加工的材料

The Toughest
For Metals





OSK
TOOL SYSTEM



地址：中国·昆山·巴城镇·迎宾西路 555 号
Add: No. 555 Yingbin Road, Kunshan, Bacheng, China
Tel: +86 512 5518 6868
Fax: +86 512 5518 6789
Email: info@osktool.com
<http://www.osktool.com>

